

VAV AIR DAMPERS (SMART BOX) WITH RD5 CONTROLS



INSTRUCTION MANUAL

- ✓ Description
- ✓ Installation
- ✓ Service
- ✓ Maintenance

1. General information, glossary of terms

1.1 Sections of the manual

1	General information, glossary of terms	6	Commissioning, warranty
2	Scope of supply, accessories, transportation, and storage	7	Maintenance and servicing
3	Description of the unit, technical data	8	Troubleshooting
4	Assembly and installation	9	Appendices
5	Control system, electrical wiring		

1.2 Table of content

1.	General information, glossary of terms	2
1.1	Sections of the manual	2
1.2	Table of content	2
1.3	Introduction	3
1.4	Description of SMART Box	3
1.5	Abbreviations and marking	4
1.6	Important to notice.....	4
1.7	Intended scope of application	5
2.	Scope of delivery, accessories, transportation and storage	5
2.1	Storage and transportation	5
2.2	Content of delivery	5
2.3	Mandatory accessories.....	5
2.4	Optional accessories	6
3.	Description and technical data	6
3.1	SMART Box technical data	6
3.2	Description of main SMART Box parts	7
3.21	Schematic and description of main parts of SMART Box C	7
3.22	Complete set SMART Box UNI, RD5, C for sizes D125, 160.....	7
3.21	Complete set SMART Box UNI, RD5, C for sizes D200, 250, 315	8
3.3	Dimensions	8
3.4	Available configurations.....	9
4.	Assembly and installation.....	10
4.1	Joining individual parts using the installation frame.....	10
4.2	Installing the SMART Box in ducting	11
4.3	Installation in suspended ceilings	11
4.4	Electrical wiring connection, cable inlet	12
4.5	Installing optional accessories – heaters and pre-heaters	12
4.6	Installing controllers.....	13
4.61	CP Touch controller.....	13
4.62	CP 10 RT, CP 10 RT 40 controller	13
5.	Control system, electrical wiring	14
5.1	SMART Box with CP Touch controller	14
5.11	Connecting the controller to the unit.....	14
5.12	Starting the display.....	16
5.13	Symbols and their meanings.....	16

5.14	Symbols on the main screen	16
5.15	Navigation symbols.....	17
5.16	Symbols fixed on the main screen	17
5.17	“Power” block.....	17
5.18	“Mode” block.....	18
5.19	List of modes	18
5.110	“Temperature” block.....	18
5.111	“Zone” block	18
5.112	User settings	19
5.113	Parameters.....	19
5.114	Control	19
5.115	Switching between HS/NHS	19
5.116	HS/NHS temperature	19
5.117	Current season	19
5.118	Control settings.....	19
5.119	Blocking IN1 (No/HS /NHS) input.....	19
5.120	Blocking IN2 (No/HS /NHS) input.....	19
5.121	Heating hysteresis	19
5.122	Cooling hysteresis.....	19
5.123	Bank holidays	20
5.124	School holidays	20
5.125	Holiday / party.....	20
5.126	Setting the weekly program	21
5.127	Copying days.....	21
5.128	Setting the network	22
5.129	Texts.....	22
5.130	Setting the display.....	22
5.131	Setting the time zone	22
5.132	Daylight saving time (summer time).....	23
5.133	SW information	23
5.134	Filter replacement indication.....	23
5.135	Table of alarms and notifications	23
5.136	Forgetful operator	24
5.2	Control system RD5 with CP 10 RT controller	24
6.	Commissioning, warranty	25
6.1	Commissioning, acceptance of warranty claims	25
6.11	Mains power connection.....	25
6.11	Required protection and mains power connection	25
6.12	Commissioning.....	25
6.2	Warranty.....	25
7.	Maintenance and servicing.....	25
7.1	SMART Box maintenance and servicing	25
7.2	Cleaning the controllers, other minor maintenance, spare parts	25
7.3	Failures, safety instructions	25
8.	Faults and troubleshooting	26
8.1	Faults and troubleshooting+	26
9.	Appendices.....	26
9.1	Capacity diagram by size	27
9.2	SMART Box internal wiring diagram	27
9.3	System connection schematic – Communication network topology	28
9.4	Reference diagram of SMART Box connections to other features	29

1.3 Introduction

The manual is intended exclusively for (VAV) SMART box variable air flow rate controllers including accessories.

1.4 Description of SMART Box

It is a compact unit designed for efficient and smart air flow rate control in line with the user’s demands.

The entire SMART box consists of the following parts:

SMART Box UNI – A base control tube of a defined diameter including the installation frame, inspection access opening and insulation.

SMART Box RD5 – A digital control module, which is a mandatory accessory and is compatible with all UNI sizes.

SMART Box C – A control tube enclosure, not mandatory.

1.5 Abbreviations and marking

E1(ODA)	- Fresh air supply from the outside to the unit
E2(SUP)	- Post-heat recovery fresh air supply to the building
I1(ETA)	- Waste air discharge from the building
I2(EHA)	- Exhaust air discharge from the unit to the outside

1.6 Important to notice

- SMART Box controllers are designed for comfort ventilation in standard environments with relative humidity rates of up to 60 %. If the unit is used for other purposes such as drying new buildings and extraction of dust or operated improperly and not in keeping with the instructions contained in the operation and maintenance manual, the manufacturer is not liable for any resulting damage.
- The units may only be installed indoors within the thermal envelope of residential buildings.
- Only adults familiar with the “Installation, use and maintenance manual” may operate the unit.
- The user must not tamper with or modify any part of the unit, particularly the power supply cables! The unit must not be used for drying construction sites or for dust, building material or other solid particle extraction.
- Only professional service technicians with relevant qualifications may perform the commissioning and repairs of the unit. Unprofessional maintenance and repairs are very risky and may result in loss of warranty.
- Before opening the access panel in order to perform cleaning, replace the filtration cloth or do basic maintenance make sure the unit is disconnected from the power supply and cannot be reconnected by another person.
- An air duct at least 2 metres long must always be attached to the unit on the fan discharge side for protection against injury caused by the fan wheel. This duct must be attached to the unit in such a way so that it can be disconnected only by using tools.
- The unit may only be installed in places where temperature does not drop below 10 °C and relative humidity up to 60 % at 20 °C.
- If the unit has been out of operation for a prolonged period of time, extra care should be taken when putting it back into operation.
- The unit, intended for standard environments, may be operated within a ventilation air temperature range of between -25 °C and 45 °C and relative humidity up to 60 %, in an environment where there is no risk of fire or explosion of flammable gases or fumes containing organic solvents or corrosive substances that might damage mechanical parts of the unit. If there is a danger of such gases and fumes temporarily entering the tube system (e.g. during floor bonding, painting), the unit must be switched off sufficiently in advance.
- Electrical connections, commissioning and adjustment of the unit may only be carried out by appropriately qualified electrical engineers. Protection must be provided using a 1 x 4 A char. B circuit breaker (each SMART Box separately).
- If additional protection against touching active and inactive parts is provided by a residual-current circuit breaker, a special residual-current device designed for circuits with frequency converters and switched-mode power supplies must be used. It is a circuit breaker sensitive to alternating, pulse and residual currents and resistant to current surges of up to 5 kA.
- Before the installation and commissioning of the unit carefully read the installation, use and maintenance manual.
- The unit and all of its accessories must be installed and used in compliance with the design, technical conditions specified by the manufacturer and applicable legislation and technical standards in effect.
- The unit may not be installed and operated in a corrosive environment that could damage its external and internal mechanical parts.
- Before putting the unit into permanent operation an initial inspection report on the appliance’s power supply must be provided and a report on commissioning and operator training must be completed.
- In the event of failure, the unit must be disconnected from the power supply as soon as possible!
- When handling the unit observe all safety rules (including safe work at heights and work with suspended loads) and use suitable work and protective unit.
- Make sure the casing of the unit is not damaged or deformed during installation.
- Units fitted with a hot-water air heater (optional accessory) must be permanently connected to the power supply to make sure frost protection is provided for the heater. If the power supply will be turned off for a prolonged period of time, the heating medium must be drained from the heater. We recommend draining the medium using pressurised air, not gravity!
- The RJ45 connector for connecting to the Ethernet network must not be connected to a network running with PoE (Power over Ethernet).

The manufacturer is not liable for damage caused by inadequate installation of the unit in line with the installation manual and general principles applied in installing air handling units and control systems

1.7 Intended scope of application

SMART Box controllers are designed for comfort ventilation (air supply and extraction control, with air supply and extraction provided by a central AHU with heat recovery and EC fans). They are designed solely for homes and flats. They can also be used in offices, schools, hotels, small facilities and similar premises.

If the unit is used for other purposes or not in keeping with the instructions for use and maintenance, the manufacturer is not liable for any resulting damage.



2. Scope of delivery, accessories, transportation and storage

2.1 Storage and transportation

- The unit may only be stored in dry, covered places with ambient temperatures between 0 and 50 °C. Units must not be stacked on top of each other and must be placed on a flat and hard surface to prevent any damage to the unit or its packaging.
- During storage the units must remain in their original, intact packaging including all spacing, tying and marking features.
- The transportation packaging may not be removed until immediately before the installation on site. Before installation the site must be checked for cleanliness. In addition, the switchboard must be checked for cleanliness and good condition and cleaned if necessary.
- During transportation the unit must be protected against falling, mechanical damage, water penetration and other adverse conditions which might damage the unit or its packaging.

2.2 Content of delivery

The full set always contains an air flow controller of the respective size, an RD5-series integrated control system, an installation frame and an operation and maintenance manual.

Content of Smart Box delivery		
		
SMART Box (2x UNI and 1x RD5 must be ordered)	The operation and maintenance manual, technical data including a commissioning report	Fixtures – 4 bolts including washers and nuts

2.3 Mandatory accessories

The mandatory accessories make up the complete set to guarantee its full functionality in line with the description in the manual. **If the set is not complete, the manufacturer does not guarantee the proper function of the unit.**

SMART Box UNI (2x)	The base control tube of a defined diameter including the installation frame, inspection access opening and insulation
SMART Box RD5	A digital control module, which is a mandatory accessory and is compatible with all UNI sizes.

2.4 Optional accessories

Optional accessories do not affect the function of the unit, which can be fully functional without these features.

SMART Box C	A control tube enclosure, optional, RAL 9006
Controllers – CP Touch, CP 10RT	The unit may be operated without a controller; in this case Internet connection is required so that the system could communicate through a web application.
EPO-V / EPO-PTC series heaters	Electric duct heaters for zonal heating of supply air (an ADS 120 duct sensor must be added).

3. Description and technical data

3.1 SMART Box technical data

SMART Box size			D125 / 125	D 160 / 160	D 200 / 200	D 250 / 250	D 315 / 315
	Item description						
Main power supply	Connecting voltage	V	230/50 Hz	230/50 Hz	230/50 Hz	230/50 Hz	230/50 Hz
	Required protection	A	1×4A char. B	1×4A char. B	1×4A char. B	1×4A char. B	1×4A char. B
Actuators	Supply / exhaust		Belimo CMV125MP	Belimo CMV160MP	BELIMO LMV-D3-MP	BELIMO LMV-D3-MP	BELIMO LMV-D3-MP
	Max. power input	W	5	5	5	5	5
Main frame	Weight without enclosure	kg	9	12	14	16	18
	Weight with enclosure	kg	10	13	16	18	20
	Outlet E2		D125	D159	D200	D250	D315
	Outlet I1		D126	D160	D200	D251	D316
External electric duct heater	EPO-V – for air re-heat *)		EPO-V 125	EPO-V 160	EPO-V 200	EPO-V 250	EPO-V 315
			EPO-PTC 160	EPO-PTC 160	EPO-V 160	EPO-V 200	EPO-V 250
Control system			RD5 bb	RD5 bb	RD5 bb	RD5 bb	RD5 bb
Controller			CP Touch	CP Touch	CP Touch	CP Touch	CP Touch
			CP 10 RT	CP 10 RT	CP 10 RT	CP 10 RT	CP 10 RT

*) when the EPO duct air heater is fitted, an ADS 120 sensor must be additionally installed downstream of the heater

3.2 Description of main SMART Box parts

3.21 Schematic and description of main parts of SMART Box C

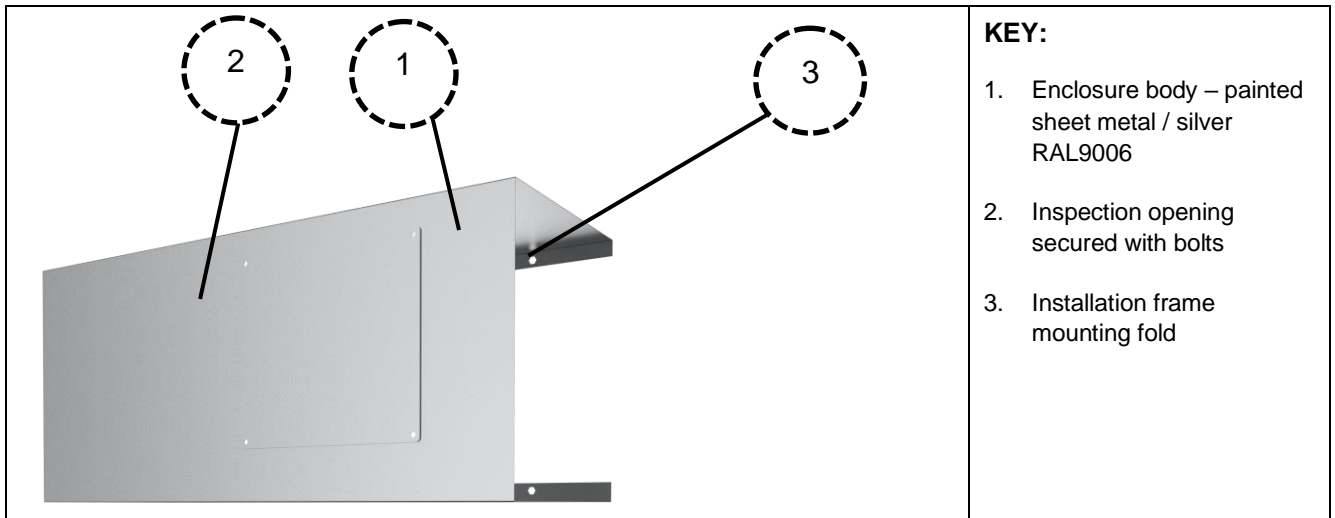

3.22 Complete set SMART Box UNI, RD5, C for sizes D125, 160

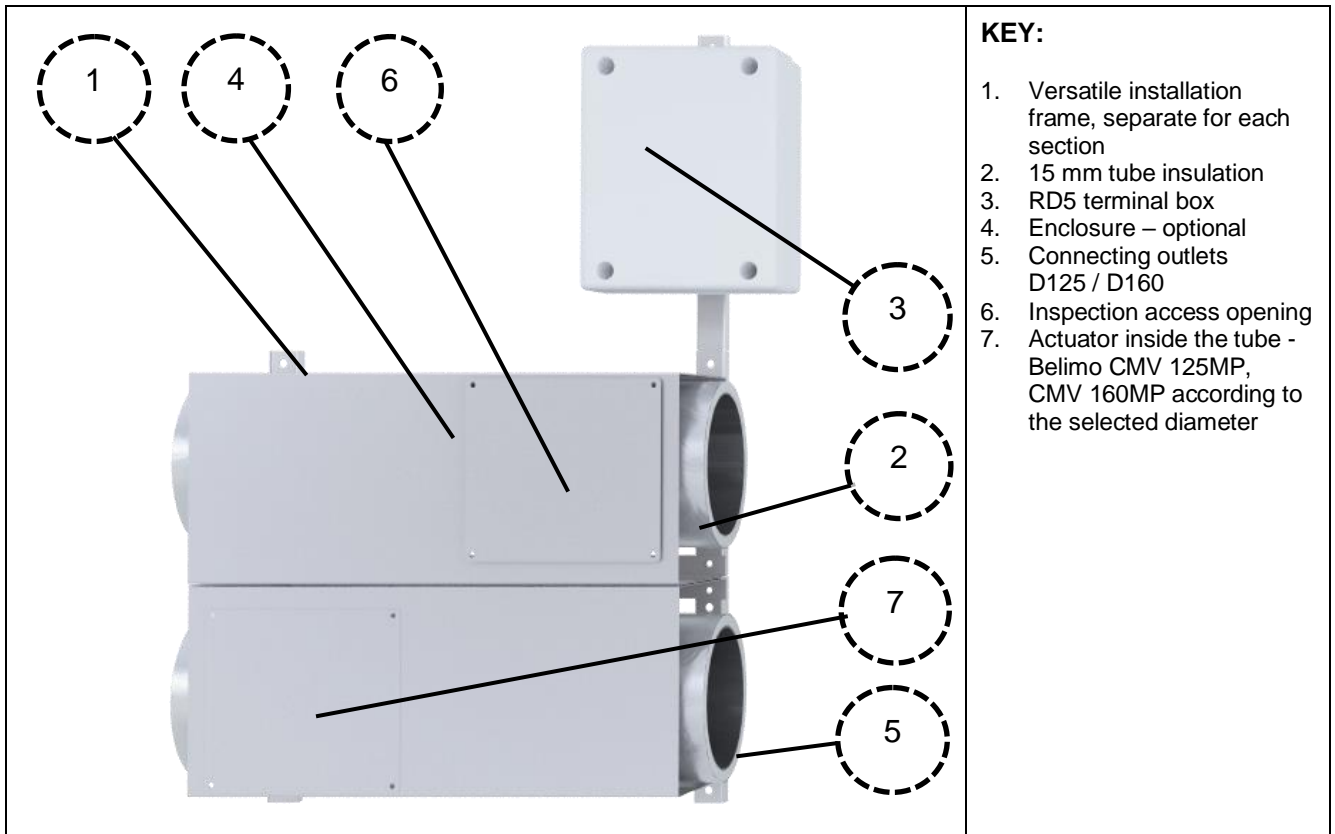

3.21 Complete set SMART Box UNI, RD5, C for sizes D200, 250, 315

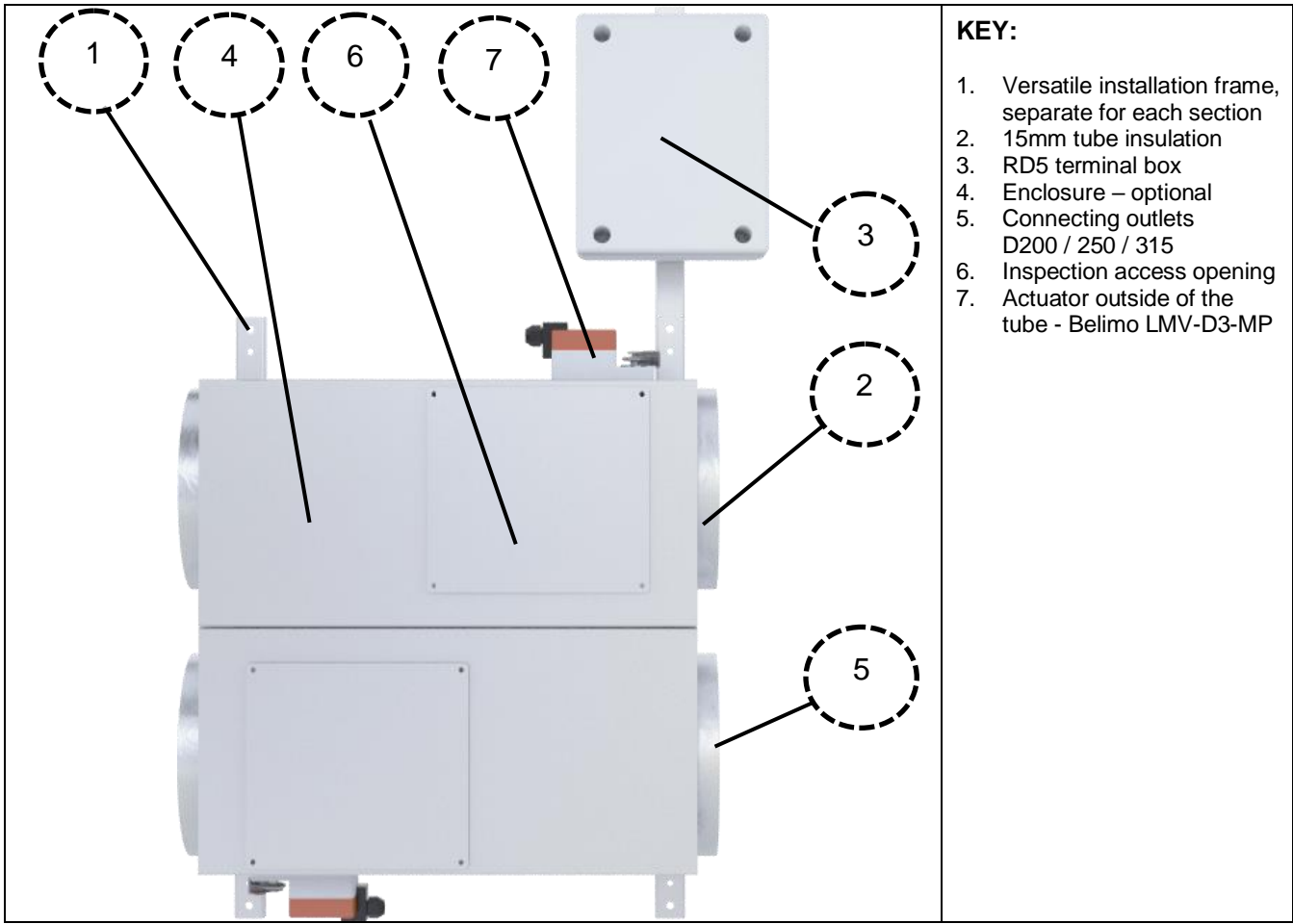

3.3 Dimensions

In order to export the dimension or even the actual SMART Box model use Duplexvent selection software (free to download from www.airflow.com).

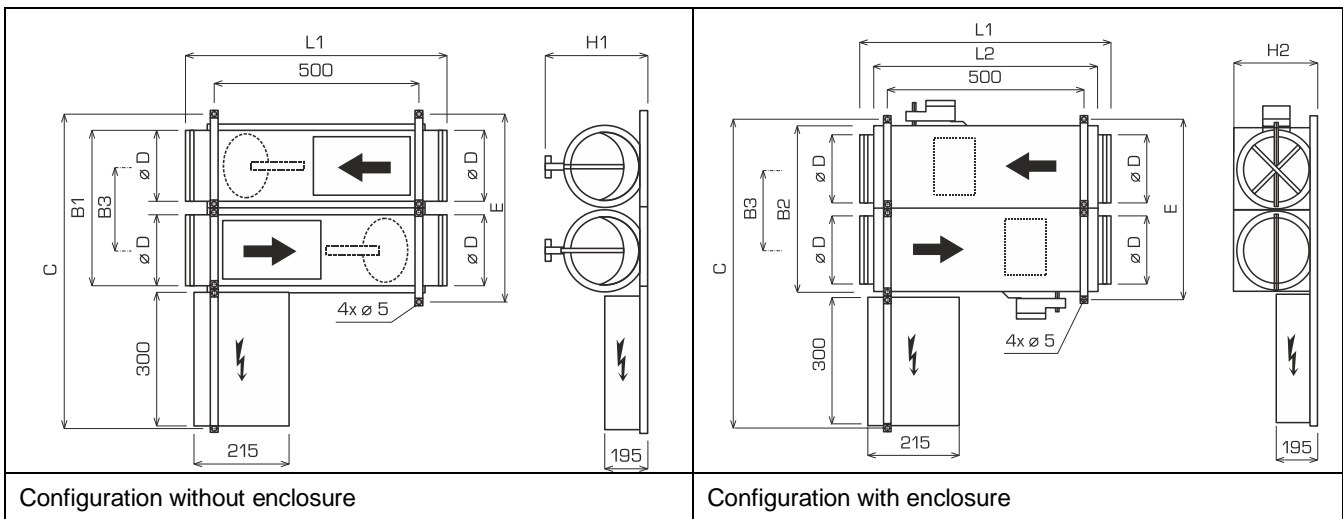

The values in brackets apply to D200 – 315 sizes if the actuators are fitted inside.

SMART box	B1 (mm)	B2 (mm)	B3 (mm)	C (mm)	D (mm)	E (mm)	L1 (mm)	L2 (mm)	H1 (mm)	H2 (mm)
125/125	387	397	198	800	125	429	590	540	155	185
160/160	457	467	235	870	160	499	590	540	190	220
200/200	537 (588)	547 (659)	304 (358)	1055	200	685	600	550	230	265
250/250	642 (698)	647 (781)	362 (418)	1175	250	804	700	650	280	315
315/315	765 (826)	777 (905)	419 (480)	1300	315	929	850	800	345	380

3.4 Available configurations

The configurations may be used for each size simply by joining the versatile installation frames, connecting their individual sections by sliding the counterpieces into each other and securing using fixtures provided.

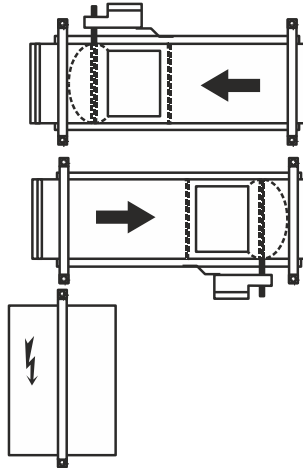
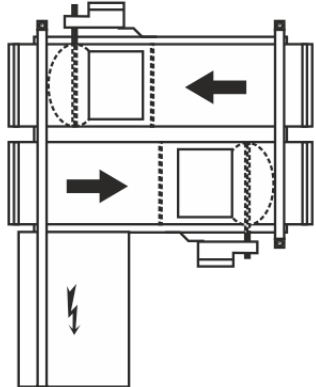
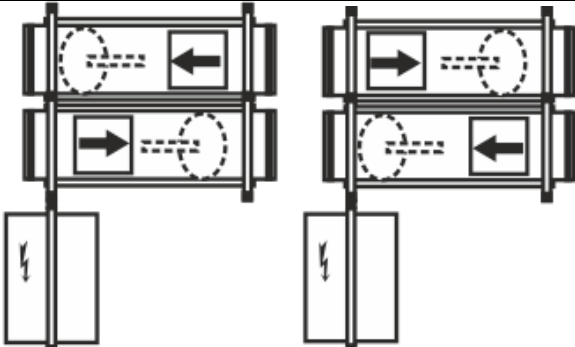
	<p>Split configuration – The basic configuration supplied. The maximum distance between the sections with cable connections from the actuator to the control system must not exceed 25 metres.</p>
	<p>Compact configuration</p> <p>This is made by joining and securing the base frames (as part of assembly on site).</p>
	<p>Mirror-wise configuration D125,160</p> <p>This is achieved by reversing the position of the tubes. The direction of air flow through the tubes must always remain unchanged.</p>

	<p>Mirror-wise configuration D200, 250, 315</p> <p>This is achieved by reversing the position of the tubes. The direction of air flow through the tubes must always remain unchanged. These sizes have different positions of the actuators – inside or outside the Box.</p>
	<p>Control system mounting</p> <p>The control system may be mounted on any side of the installation frame or is left uncoupled (the actuators must always be connected).</p>

4. Assembly and installation

The assembly and installation of the unit may be carried out only by competent persons. The unit can only be installed in designated areas specified in this instructional manual.

Always disconnect the power supply during installation!



4.1 Joining individual parts using the installation frame

The components, supplied separately in the basic delivery package, may be joined together as required by sliding the ends on the installation frame into the counterpieces and securing them using the bolts provided.

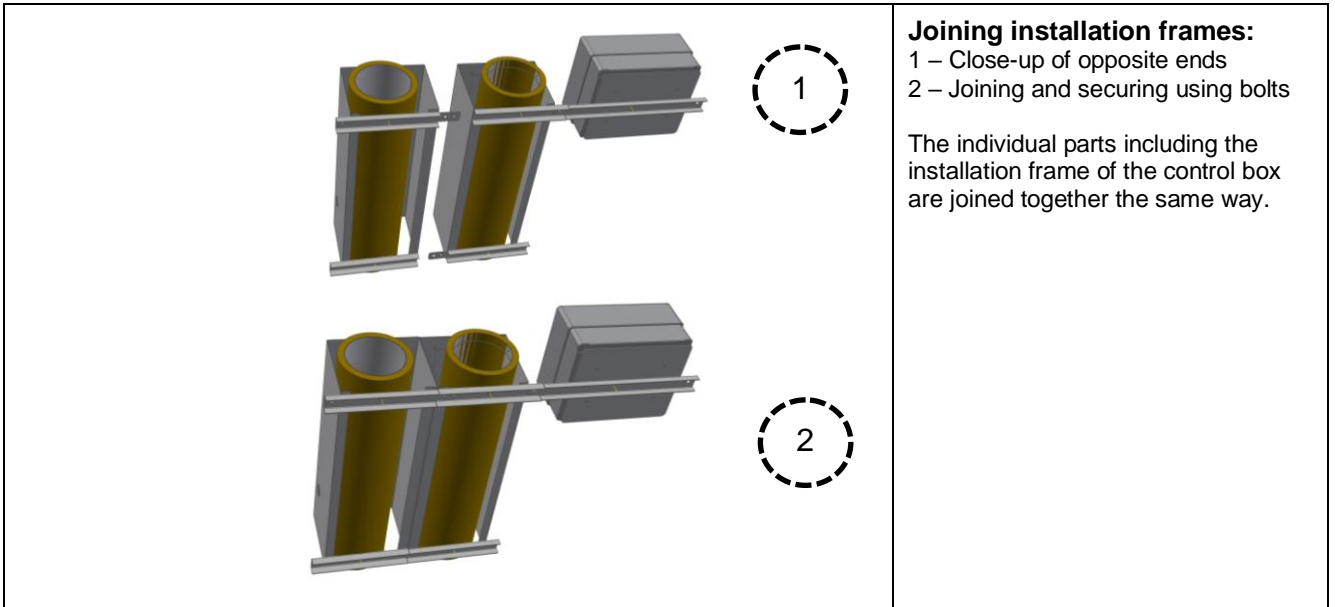

4.2 Installing the SMART Box in ducting

The components are preferably mounted on the ceiling; if necessary, they can also be mounted on the wall in the so-called floor standing position. Each component must be securely mounted to the building structure using the holes in the installation frame. The anchoring fixtures are not included.

In order to make sure air flow rates are measured with required accuracy straight sections **at least three times the connecting diameter in length** must be fitted before the air inlet. If these distances are not maintained, the manufacturer is not liable for air flow measurement errors.

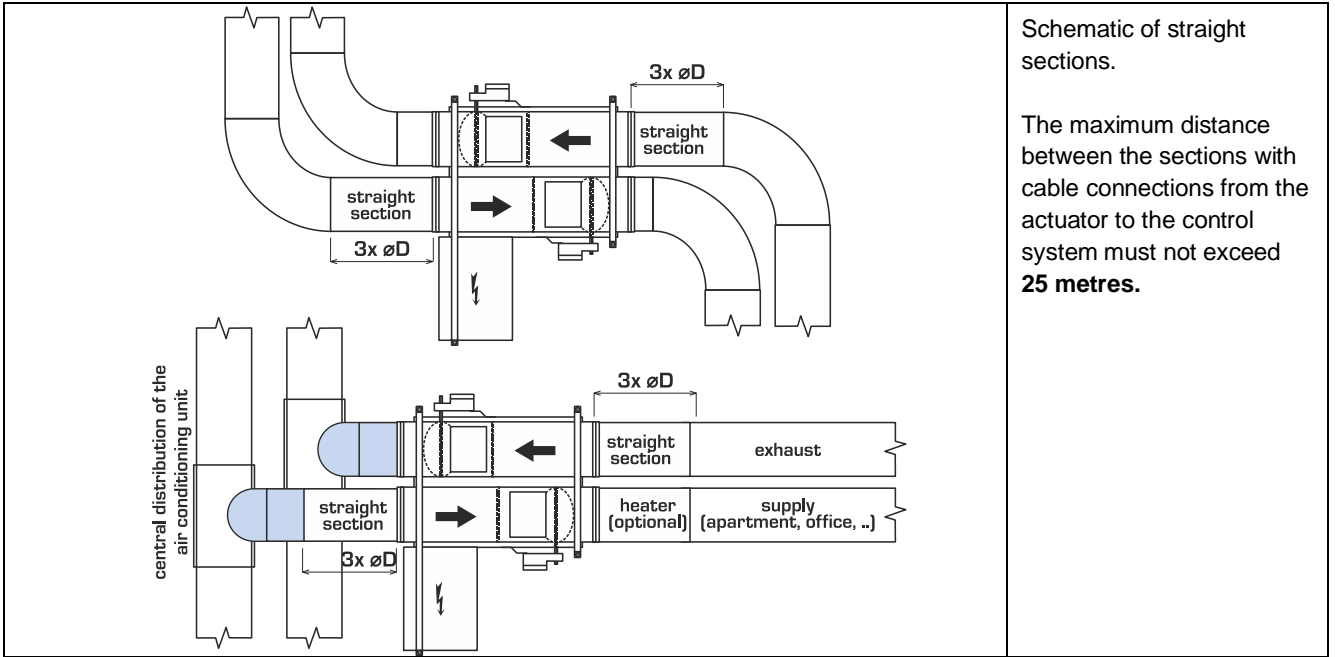

4.3 Installation in suspended ceilings

When installed in a suspended ceiling, it is necessary to keep permanent access for system commissioning and servicing. Using a one-piece (not folding) inspection access panel is recommended.

SMART box	X (mm)	Y* (mm)	Z (mm)
125/125	750	500	225
160/160	850	500	225
200/200	1 000	650	270
250/250	1 100	750	320
315/315	1 250	850	385
400/400	1 450	900	480

Recommended inspection access opening sizes according to SB dimensions.

4.4 Electrical wiring connection, cable inlet

The individual cable connections to the control system including the power supply are provided to the SMART Box RD5 section through rubber bushings.

Cable inlet to the SMART Box RD5 module.

As part of preparatory work the power supply and peripheries such as heaters and sensors including SMART Box actuators MP1 and MP2 must be connected following the schematic in appendix 9.2.

The marking is shown on the plate of the SMART Box UNI tube.

4.5 Installing optional accessories – heaters and pre-heaters

The following internal or external pre-heaters and re-heaters are available for connecting to the units:



- The external electric re-heater EPO-PTC located along the exhaust air route into the building. The heater has autonomous controls (thermostats) and safe operation protection features. An ADS 120 sensor must be added downstream of the heater.
- The external electric re-heater EPO-V with an ADS 120 sensor to be added downstream of the heater.

The installation and connection instructions and the wiring diagram of these external components are supplied with them. Other types of electric heaters may not be used.

4.6 Installing controllers





Notice: Before installing or removing a controller disconnect the ventilation unit from the power supply. Handling a live controller could lead to electrocuting or cause damage to the controller. This applies to all controller types.

Each of the controllers is compatible only with the control system specified. Using them with different control system types may lead to damage to the unit.

4.61 CP Touch controller

The CP 10 RT controller type is used to fully control and programme the unit – **optional**. It is supplied for wall mounting. It can be mounted on a standard enclosure with a hole spacing of 68 mm.

The controller should be installed on the wall at a height of 1.3 to 1.5 m in a place that is easily accessible, well-lit and dry, away from heaters or radiant surfaces – it contains an internal thermostat. Use a shielded connecting cable (SYKFY 2x2x0.5). When the controller needs to be further away from the ventilation unit, the cable must be replaced / extended (up to 25 metres). The controller is installed by a specialist electrical engineer.

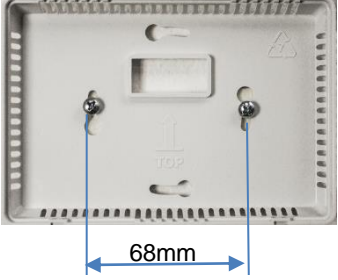
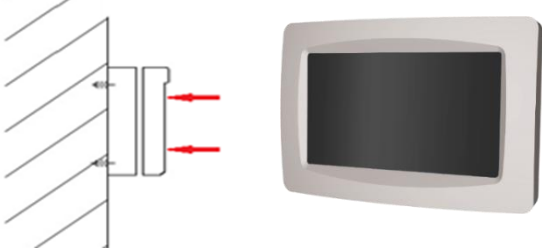
 <p>Press here</p>	 <p>The enclosure can be clicked together in one direction only</p>
<p>Step 1: Before installation dismantle the controller and remove the front panel from the rear part.</p>	<p>Step 2: Hold the rear part to the appropriate place on the wall and attach it using screws.</p>
	
<p>Step 3: Click the front panel with display on to the rear part mounted on the wall.</p>	<p>Step 4: The controller mounted on the wall.</p>

4.62 CP 10 RT, CP 10 RT 40 controller

The CP 10 RT controller type is used for ventilation power and supply air temperature control – **optional**. It can be mounted on a standard enclosure with a hole spacing of 68 mm.

The controller should be installed on the wall at a height of 1.3 to 1.5 m in a place that is easily accessible, well-lit and dry, away from heaters or radiant surfaces – it contains an internal thermostat. Use a shielded connecting cable (SYKFY 5x2x0.5). When the controller needs to be further away from the ventilation unit, the cable must be replaced / extended (up to 25 metres). The controller is installed by a specialist electrical engineer.

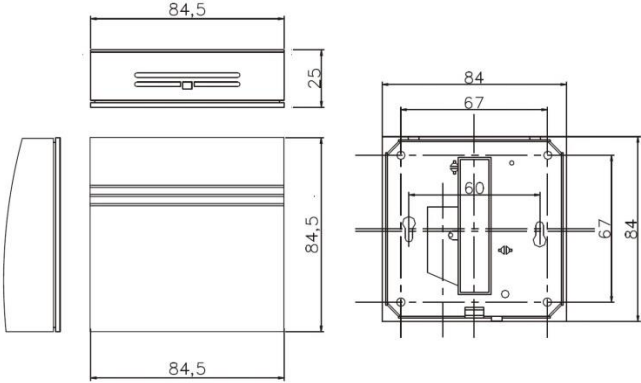
	
<p>CP10RT</p>	<p>Wall mounting</p>

5. Control system, electrical wiring

Any work on the control system (replacing / removing sensors, checking connections of individual parts etc.) must be done when the system is not live (after disconnecting the power supply)!



5.1 SMART Box with CP Touch controller

The **CP Touch** controller can be connected to units fitted with an RD5 control board. The CP Touch provides full control for these units, i.e. user and service parameter settings (often protected by a password). It has a manual mode, through which the user directly selects the unit's operation, or a weekly mode, which controls the unit using weekly program settings (6.8).

5.1.1 Connecting the controller to the unit

Connect the controller to the unit as shown in the wiring diagram inside the lid of the AHU's electrical box.

If more than one controller is connected, they must be connected to each other in a series.

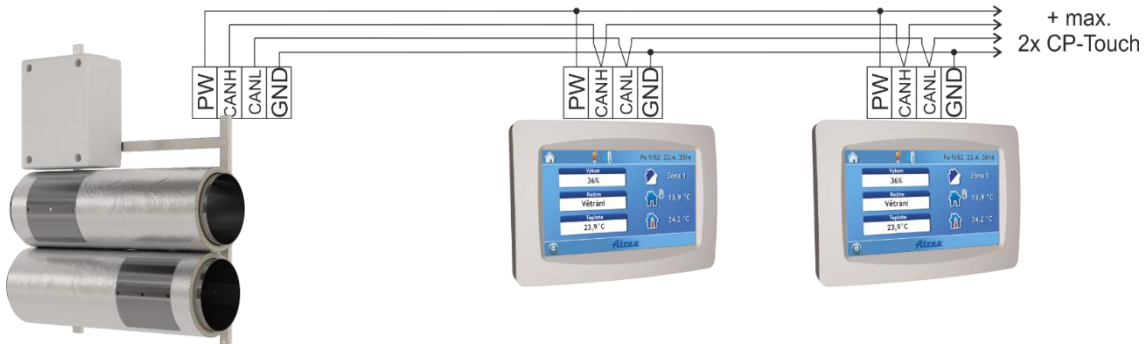

Note

According to the diagram there can be **up four controllers connected to a single unit with RD5 control system**. The last controller connected to the bus bar must have an activated termination resistor – jumper short circuit.

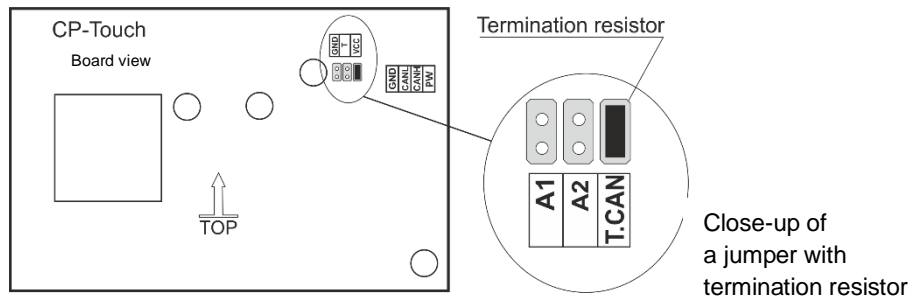

The back of the controller board has jumpers at designated points as shown in Fig. 2 and 3:

T.CAN – A termination resistor jumper; the jumper must be fitted on the last controller in line.

A1 – 1st controller addressing jumper

A2 – 2nd controller addressing jumper

The jumpers of each controller on the same bus bar must have a different address.

The table shows controller connection options. When more controllers are installed, their addressing must be different. The last controller in the series must be terminated with a **Number** jumper.

Number of controllers connected	A1	A2	T.CAN
1	0	0	✓
1	0	0	0
2	✓	0	✓

1	0	0	0
2	✓	0	0
3	0	✓	✓

1	0	0	0
2	✓	0	0
3	0	✓	0
4	✓	✓	✓

0Unconnected jumper

✓Connected jumper

Controller description and function

Turn on the light of the controller by clicking on the dark screen. The CP Touch controller can be connected to DUPLEX units equipped with the RD5 board. The controller is used for full control of DUPLEX units, that is to say, user settings and password-protected service parameters settings.

The controller provides the following:

- A manual mode for directly selecting the mode of operation of the unit by the user.
- A weekly mode to run the unit according to a weekly program.

5.12 Starting the display

Once the power supply is started, the **CP Touch** controller displays a start screen with additional information on the status of communication with the unit.

Text/Status	Controller action
Waiting for status	The launch application is waiting for the controller's executing part to start up; this takes approximately 10 seconds.
Loading application	Loading of the application in the controller, which takes up to 10 seconds. The controller screen may darken for several seconds.
Downloading application	An updated version of the application is being downloaded from the control board; this may take approximately 4 minutes.
Waiting for connection	The controller is waiting for communication with the control board; if this takes more than 3 minutes, the screen switches to "Communication Error"
Main screen appears, but data are "0"	The controller's application has loaded properly, but communication with AHU controls is not available yet. This status may appear after switching the unit's power supply when the control module application has not been launched yet after starting power supply. It should not last longer than 1 minute.
Communication error	Communication between the controller and the unit has not been established. A new attempt to connect is made after restarting power supply.

Main screen:

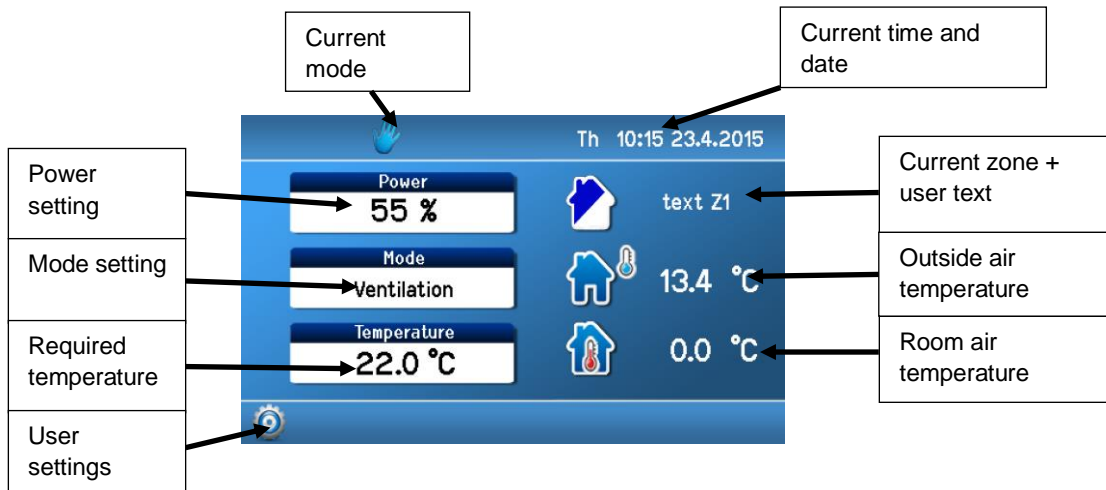





To adjust parameters on the main screen, click on a parameter.

5.13 Symbols and their meanings

Required parameter setting mode symbols; one of the symbols is always displayed.

5.14 Symbols on the main screen

Group 1		Manual control of the unit
Group 2		Unit control according to a weekly program
		Temporary manual change of the weekly program
Group 3		Party/Holiday mode active

		Bank holiday mode active
Group 4	 	Symbol indicates heating Symbol indicates cooling
Group 5	 	Active alarm symbol (yellow) 8 Active notification symbol (blue) 8

5.15 Navigation symbols

	Clicking returns the screen one level back
	Clicking returns the screen to the main screen
	Current language icon; clicking on the flag shows the page with language settings

5.16 Symbols fixed on the main screen

	Next to this symbol, outside air temperature T-ODA is shown
	If extraction / room temperature control is used, interior temperature T-IDA is shown (room or extraction air temperature)
	If supply air temperature control is used, supply air temperature T-SUP is shown
	User interface access icon
	Service settings accessible after entering a password; any data in the service settings may be edited only by an authorized service technician.

5.17 “Power” block

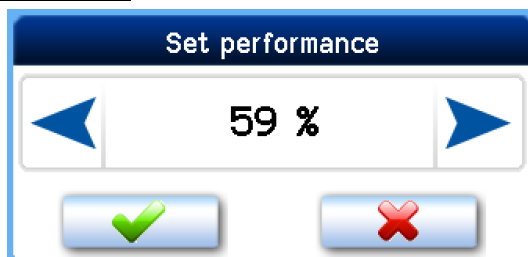

It shows the unit's current power level in % or m³/h according to the configuration of the unit. The current power level value may not correspond to the value set manually or in the weekly program. If that is the case, the power level required is generated by a closed input or a connected sensor such as that of CO₂ concentration.

5.18 **“Mode” block**

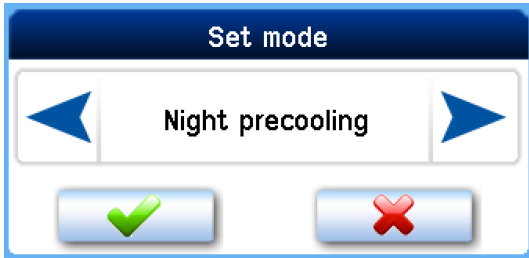

It shows a mode current at any given time, with options as provided by the unit's configuration. The current mode parameter may not correspond to the parameter set manually or in the weekly program. If that is the case, the power level required is generated by a closed input D1–D4 or one of the inputs IN1–INk4/2.

5.19 **List of modes**

OFF – The unit is switched off.

Automatic - The unit is in “OFF” mode. It is started by the periodic ventilation timer or when input status changes (Dn, INk).

Ventilation – The unit is ventilating at a power level set or higher as set by an external input which is active.

5.110 **“Temperature” block**

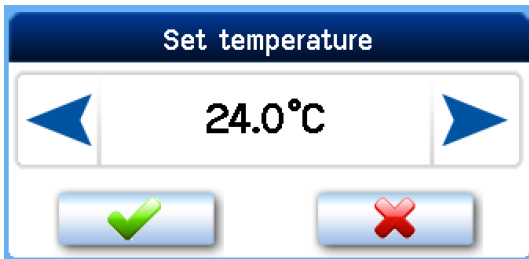

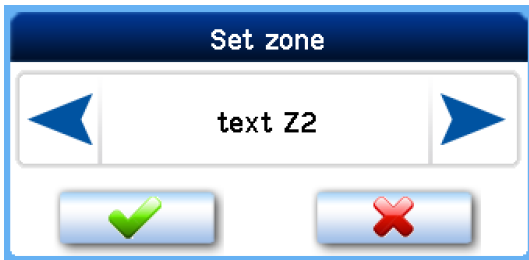

It displays temperature in °C current at any given time. The current temperature level value may not correspond to the value set manually or in the weekly program. If that is the case, the temperature required is generated by a closed input D1– D4 and parameters set for one of these inputs if a specific temperature for Dn inputs is set.

5.111 **“Zone” block**



It shows a ventilation zone required at any given time.

Zone ventilation is set by clicking on the Zone icon  on the main screen. The zone requirement current at the time may not correspond to the value set manually or in the weekly program. If that is the case, the zone requirement is generated by a closed input D1 – D4 and parameters set for one of these inputs.

Note: Zone texts can be set, for more information see  6.6. The initial zone description setting is: Text Z1 / Text Z2 / Text Z1+Z2. Active ventilation zone symbols with captions:

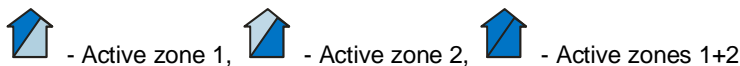

5.112 User settings



By pressing the button  on the main screen user setting options are displayed.

5.113 Parameters

The “Parameters” options allow choosing operating parameters, setting the HS/NHS parameters and setting automatic switching between HS and NHS.

5.114 Control

“Manual” – The operating modes of the unit are selected directly by the user.

“Weekly program” – The unit is controlled according to the weekly program.

5.115 Switching between HS/NHS

This allows setting the heating or non-heating season or automatic switching between them.

“NO” – The IN1 input (analogue control input) is always effective.

“HS” – Heating season; supply air heating or room heating is allowed.

“NHS” – Non-heating season; supply air cooling or room cooling is allowed.

“T ODA-” – Automatic switching between HS/NHS based on outside temperature. The changeover value is set by parameter “Temperature HS/NHS” ( 6.1.3). If outside temperature is higher than Temperature HS/NHS, the Non-heating season is selected automatically. If outside temperature is lower than Temperature HS/NHS, the Heating season is selected automatically.

“T ODA+” – Automatic switching between HS/NHS based on outside temperature and a ratio between required and room temperatures. The changeover value is set by parameter “Temperature HS/NHS”.

Note

- If outside temperature is higher than Temperature HS/NHS, the Non-heating season is selected automatically.
- If outside temperature is lower than Temperature HS/NHS and at the same time room temperature is higher than the required temperature by more than 5°C, the NHS remains active until outside temperature does not drop below 0°C.
- If outside temperature is lower than 0°C, the HS is always set automatically.

5.116 HS/NHS temperature

An outside air temperature level for automatic switching between the HS and NHS.

5.117 Current season

Indication of a season currently selected – HS or NHS. This parameter is not for setting, only for information.

5.118 Control settings

Settings in this chapter describe the conditions of ventilation operation by the AHU.

5.119 Blocking IN1 (No/HS /NHS) input

The effect of input IN1 on the ventilation unit’s operation may be limited according to the season currently selected at the time.

“No” – The IN1 input is always effective.

“NHS” – The effect of input IN1 on the unit’s operation is blocked during the Non-heating season.

“HS” – The effect of the IN1 input on the unit’s operation is blocked during the Heating season.

5.120 Blocking IN2 (No/HS /NHS) input

The effect of analogue input IN2 on the ventilation unit’s operation may be limited according to the season currently selected at the time.

“No” – The IN2 input is always effective.

“NHS” – The effect of input IN2 on the unit’s operation is blocked during the Non-heating season.

“HS” – The effect of the IN2 input on the unit’s operation is blocked during the Heating season.

5.121 Heating hysteresis

To set a temperature difference compared to the temperature required to start heating. The setting range is between 0.1 °C and 5°C (0.1°C steps).

5.122 Cooling hysteresis

To set a temperature difference compared to the temperature required to start cooling. The setting range is between 0.1 °C and 5°C (0.1°C steps).

5.123 Bank holidays

Settings as per user requirements; up to sixteen different dates can be set.

Steps for bank holiday settings:

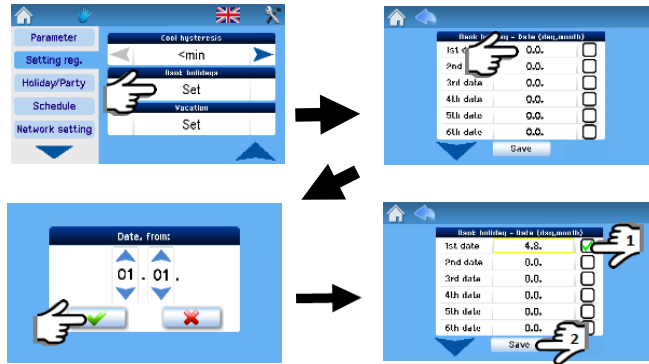

Note: The AHU unit is controlled according to bank holiday settings when:

- The unit is in weekly program control mode
- There is a bank or school holiday on the day current at the time
- The bank holiday (school holiday) date is checked in the holiday settings
-

5.124 School holidays

Settings as per user requirements; up to four different holiday periods can be set.

Steps for school holiday settings:

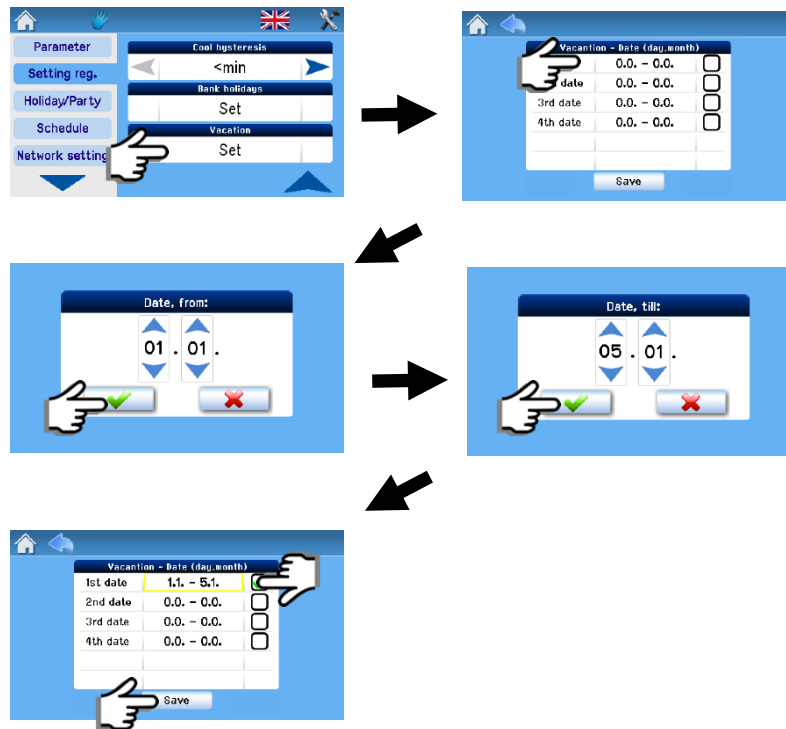

5.125 Holiday / party

This is a mode set for a limited period of time during which the unit's operation is other than in regular modes, such as when the unit is normally run according to the weekly program and should be switched temporarily to economy mode for example for a week when there is no occupancy in the house.

When the parameters set for the Holiday/Party function have been stored, the unit is activated for operation according to these parameters; these cannot be subsequently modified or the unit's operation mode changed until the period set expires or the Holiday/Party function is deactivated manually (Deactivation button).

The settings below apply when the Holiday/Party mode has been activated.

Power: For Power settings see 5.1.

Mode: For Mode settings see 5.19.

Temperature: For Temperature settings see 5.111.

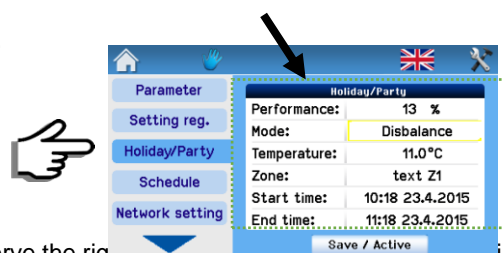

Zone: For Zone settings see  5.112.

Start time: The starting time of the mode may be delayed; the Holiday/Party mode starts according to the start time set.

End time: The Holiday/Party mode ends according to the end time set.

“Store/Activate” mode button: It serves for storing the parameters set. The mode is activated and deactivated according to the start and end times set. (After pressing, this button changes to the “Deactivate” button).

5.126 Setting the weekly program

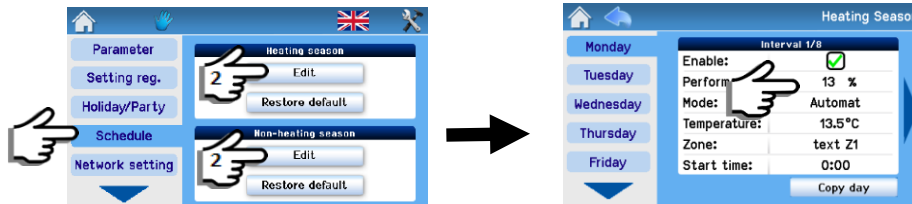

The weekly program is set separately of the heating and non-heating season.

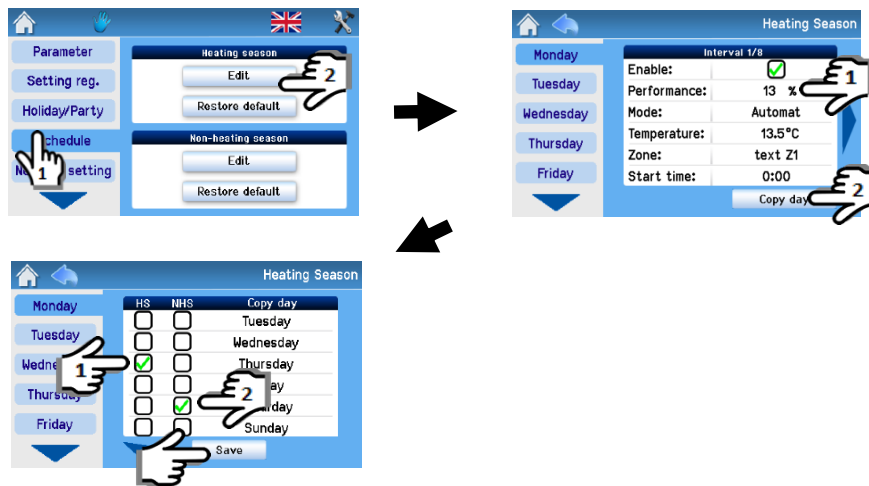

5.127 Copying days

Settings may be copied between days as shown below:





Example of copying: When copying, first check Wednesday in HS  and then Thursday in NHS , thereby copying all settings for Wednesday in HS to Thursday in NHS.

Settings for each season provide eight intervals for each day of the week and separate settings for Bank holidays and School holidays. Each interval allows setting all operating parameters of the AHU and the start time of the interval.

Unless the first interval of a given day starts at 00:00, the unit continues to run with parameters set by the last interval of the previous day until the first interval start time.

Note

Use the arrows  and  to move between all eight intervals (days)

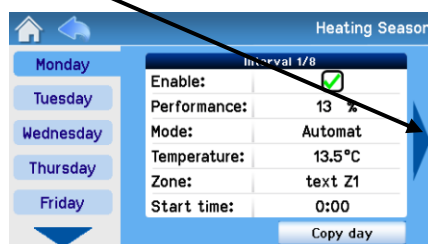

The weekly program allows copying and pasting the settings of a selected day as follows:

- Into each day of the week
- Into selected days
- Into Bank holidays / School holidays
- Into Heating and Non-heating season days

5.128 Setting the network

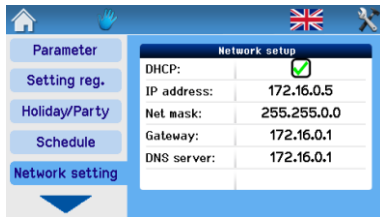

DHCP: When checked, the network is automatically set from the internet; if not checked, the network must be set manually

Note

The “Save” button records the values set and also immediately restarts with new values.

5.129 Texts

The “Texts” parameter is used for changing adjustable texts as required.

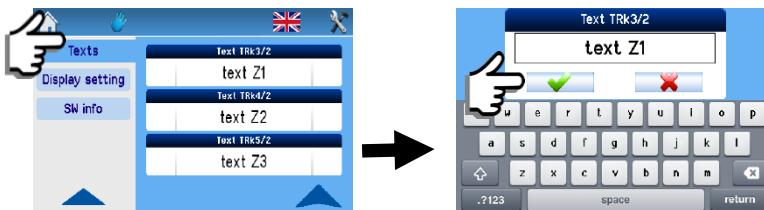





Note

The texts can be adjusted as required and are the same as those for setting from the web. The respective text is shown in the “Mode” box of the unit switches to the mode according to this input.

D1–D4, IN1, IN2, Zone 1, Zone 2, Zone 1+2, INk1–INk4, T

5.130 Setting the display

In this section you can set the basic parameters of the display:

- Backlight setting** The display backlight is changed using the setting arrows; see Fig. 16    
- Internet time sync** Time sync with the internet is done by checking this option as shown in Fig. 16; the update is done immediately.
- Time and date setting** The date and time are set by clicking.



In the event of a power cut resulting in wrong time settings it is necessary change the internal battery on the RD-int board.

- The internal power supply battery type is CR 2032; it is located in the control module on the RD-int board.
- Replacement must be done by a competent service technician.



5.131 Setting the time zone

The time zone setting according to the location of the unit done by the setting arrows.

5.132 **Daylight saving time (summer time)**

An option to switch automatically between the daylight saving and standard time.

5.133 **SW information**

It displays information on the type of the unit, its manufacturing number and the version of the control software.



5.134 **Filter replacement indication**

In some units, the “Filter replacement” notification is also shown by the button for filter replacement confirmation (by pressing this button the date of subsequent filter replacement is saved).



5.135 **Table of alarms and notifications**

The messages shown in the table below provide information on irregular or unexpected events in the AHU's system.

Table of alarms (yellow triangle) 

Message	Meaning	What to do?
Room temperature sensor	Failure of the room temperature sensor connected to the CP-Touch controller.	Contact a service technician.
TEa temperature sensor	Communication breakdown or failure of the TEa temperature sensor.	Contact a service technician.
TEb temperature sensor	Communication breakdown or failure of the TEb temperature sensor.	Contact a service technician.
Temperature sensor downstream of TA2 external heater	Communication breakdown or failure of the temperature sensor downstream the warm water or electric heater.	Contact a service technician.
1 st frost protection level	Temperature downstream of the heater is lower than 9°C.	The unit is running according to the set program, the warm water supply opens to a maximum.
2 nd frost protection level	Temperature downstream of the heater is lower than 7°C.	Check the warm water supply. The fans stop, AHU warm water supply opens.
STOP circuit active	The emergency stop contact is opened.	The stop contact has been activated by a fire or other safety system; check its status.
Temperature sensor TU1	Communication breakdown or failure of the TU1 fan temperature sensor in the unit.	Contact a service technician.

Temperature sensor TU2	Communication breakdown or failure of the TU2 fan temperature sensor in the unit.	Contact a service technician.
Heater setting	The heater type is not set (water or electrical).	This parameter blocks the operation of the unit and must be set in the service menu. Contact a service technician.
AHU overheat	One of the temperature sensors has detected a temperature higher than 77°C.	Disconnect the unit from power supply and, if there is no risk of overheating in the room (fire etc.), reconnect it.
Communication error	Breakdown communication between the controller and AHU.	Check whether the cable between the unit and controller is not interrupted or contact a service technician.

Table of notifications (blue triangle) 

Insufficient heating capacity of heater 1	The heating capacity of the unit's heater is not sufficient.	Check the status of primary heating. The unit has switched to heating from its back-up source.
Insufficient air flow rate	The air volume flowing through the unit is not sufficient.	Contact a service technician. Check the condition of filters.
"AI input"	The unit received an external alarm signal.	Contact a service technician.
The unit is not operational	The unit has not been commissioned by a certified technician.	Contact a service technician.

5.136 Forgetful operator

After the ventilation period set has expired, the command on the D1-D4 input is deactivated. This function limits the duration of the AHU running time.

5.2 Control system RD5 with CP 10 RT controller

The controller is used for mechanical ventilation control, selecting supply air temperature, switching the unit on and off and failure indication. For connection see chapter 4. The controller can be used in combination with the CP Touch controller or web control.

Description of functions:

- Ventilation capacity setting in a range of 0; 10–100 %.
- Switching the unit on and off using the button (mechanical lock in position).
- Starts supply air re-heating, with the second power selector increasing temperature in a range of 15–25 °C.
- Re-heater operation indicated by the green light of the indicator – NOT AVAILABLE FOR SMART BOX.
- Various LEDs for unit status indication – NOT AVAILABLE FOR SMART BOX.

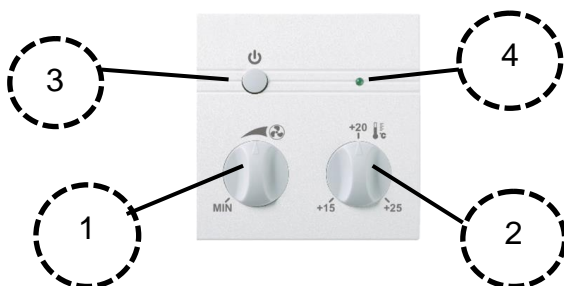

KEY:

- 1 – Rotary power range selector 10–100 %
 - 2 – Rotary supply air temperature selector – re-heating in range 15–25 °C (for CP 10RT 40 up to +40 °C)
 - 3 – ON/OFF button
 - 4 – Indicator LED -.NOT AVAILABLE FOR SMART BOX
- Green - ON** => the unit's ventilation capacity corresponds to the value set on the controller
Green - flashing => the unit's ventilation capacity is higher than the value set on the controller (e.g. due to an active external signal)
Red - ON => the system indicates failure (the exact kind of failure can be found on the web)

6. Commissioning, warranty



6.1 Commissioning, acceptance of warranty claims

Any work on the control system (replacing / removing sensors, checking connections of individual parts etc.) must be done when the system is not live (after disconnecting the power supply)!

6.11 Mains power connection

The mains power connection can only be performed by persons acquainted with CSN 332000-3 Art. 322.1-BA 5 (and IEC 364-3 Art. 322.1-BA 5) – that is, low-voltage electrical installations. For Slovakia: In keeping with Decree 74/1996 Z.z., And Decree 57/78 Zb.).

The inspection of the wiring should ideally be carried out once a year, with the required maximum interval once every 3–5 years.

6.11 Required protection and mains power connection

All units must be connected only as part of a definitive 230V/50HZ 1F power supply system, with protection 1×4A char. B and required connections at least CYKY 3J×1.5.

6.12 Commissioning

The entire system can only be commissioned by a competent person. As part of commissioning the installer must complete a commissioning report, which is used for recording all value settings and the date of commissioning.

To access the unit remotely, the system must be connected to the Internet.

6.2 Warranty

The warranty period is in line with the **General Terms and Conditions**, which means the standard period of **2 years**.

7. Maintenance and servicing

7.1 SMART Box maintenance and servicing

General maintenance such as the cleaning of the interior can be done by the user. For servicing or work on the electric parts of the system, use competent service technicians.

- Maintenance consists of visual inspection and cleaning of the unit using a cloth and water without any solvents.
- During maintenance observe personal health and safety and use protective equipment (face mask, packaging for contaminated filters).
- Before opening the inspection access panel always disconnect the unit from the power supply (by the circuit breaker or fuse disconnecter or by unplugging it if it is connected this way).
- During maintenance observe the safety instructions provided in the manual (“Important to notice”), follow the general rules of occupational safety and use a suitable means of access to HVAC equipment (ladders, stepladders).

7.2 Cleaning the controllers, other minor maintenance, spare parts

The controller of the unit is maintained like a light switch – cleaning is possible only using a dry or slightly wet cloth so that no water penetrates inside the controller. Cleaners that might damage its surface (e.g. organic solvents) must not be used. Other than that carry out only the following as necessary:

- Check the condition of door seals. We recommend applying silicon oil to the seal once a year to extend its life span.
- If some sections of the unit are covered in dust, clean them using a slightly wet cloth.

All warranty and post-warranty repairs can only be carried out by a specialist firm, not DIY.

7.3 Failures, safety instructions

As a preventative measure it is necessary to check regularly whether the unit does not display any failure or warning messages calling for inspection as timely action allows taking simple solutions.

Fire emergency procedure

- Unplug the unit.
- Carry out any rescue work only when using personal protective equipment (protective gloves, eye protection, a breathing apparatus or a mask with filter against organic fumes).
- If necessary call the numbers for ambulance, fire brigade, police.

The unit is not designed for exposure to wet environments or even water. Cleaning (chapter 7.1) is done using a dry or slightly wet cloth.

8. Faults and troubleshooting

8.1 Faults and troubleshooting+

Fault	Description	Possible cause	Troubleshooting
The unit cannot be started	<ul style="list-style-type: none"> The unit remains idle even after the required performance level was selected 	<ul style="list-style-type: none"> Power supply is not connected 	<ul style="list-style-type: none"> Connect the unit to power supply (switch on upstream safety circuit breakers)
		<ul style="list-style-type: none"> The unit's operation is being blocked by the external input "operation allowed" (e.g. from the fire damper etc.) 	<ul style="list-style-type: none"> Check and contact a service technician if necessary
		<ul style="list-style-type: none"> Not found 	<ul style="list-style-type: none"> Disconnect from power supply and contact a service technician
The unit is not supplying enough air	<ul style="list-style-type: none"> The unit is providing a significantly lower volume of air 	<ul style="list-style-type: none"> Insufficient power from the central unit 	<ul style="list-style-type: none"> Contact a service technician
		<ul style="list-style-type: none"> A mechanical obstacle at fresh air suction or supply air outlets 	<ul style="list-style-type: none"> Check whether the suction openings of fresh air or supply air outlets are not mechanically covered Remove any obstacles Visually and by listening check whether the dampers open properly
		<ul style="list-style-type: none"> Not found 	<ul style="list-style-type: none"> Disconnect from power supply and contact a service technician
The unit is not heating or is heating insufficiently	<ul style="list-style-type: none"> After selecting the required temperature level the supply air is still cold The actual air temperature does not reach the required level 	<ul style="list-style-type: none"> The electric heater is not connected to the power supply 	<ul style="list-style-type: none"> Connect the unit to the power supply (switch on upstream safety circuit breakers)
		<ul style="list-style-type: none"> Electric heater thermal protection response 	<ul style="list-style-type: none"> Wait. If the fault does not disappear on its own within approx. one hour, press the RESET button on the electric heater. If this does not remove the fault, or if the fault appears repeatedly, contact a service technician.
		<ul style="list-style-type: none"> Low maximum capacity of the heater 	<ul style="list-style-type: none"> Does not constitute a fault (insufficient capacity designed)
		<ul style="list-style-type: none"> Not found 	<ul style="list-style-type: none"> Disconnect from power supply and contact a service technician
	<ul style="list-style-type: none"> When the heater has been started, supply air continues to be cold 	<ul style="list-style-type: none"> The choke valve actuator is not working, is still in one position 	<ul style="list-style-type: none"> Check if the HS (heating season) period is set; if yes, contact a service technician.
		<ul style="list-style-type: none"> Air in the hot-water air heater 	<ul style="list-style-type: none"> Check heating water temperature Bleed air
		<ul style="list-style-type: none"> Heating water temperature in the heater too low 	<ul style="list-style-type: none"> Check heating water temperature
		<ul style="list-style-type: none"> Heating water flow rate too low 	<ul style="list-style-type: none"> Check the condition of the sludge filter at the heating water inlet; clean the filter
		<ul style="list-style-type: none"> Low maximum capacity of the heater 	<ul style="list-style-type: none"> Does not constitute a fault (insufficient capacity designed)
		<ul style="list-style-type: none"> Not found 	<ul style="list-style-type: none"> Disconnect from power supply and contact a service technician

9. Appendices

9.1 Capacity diagram by size

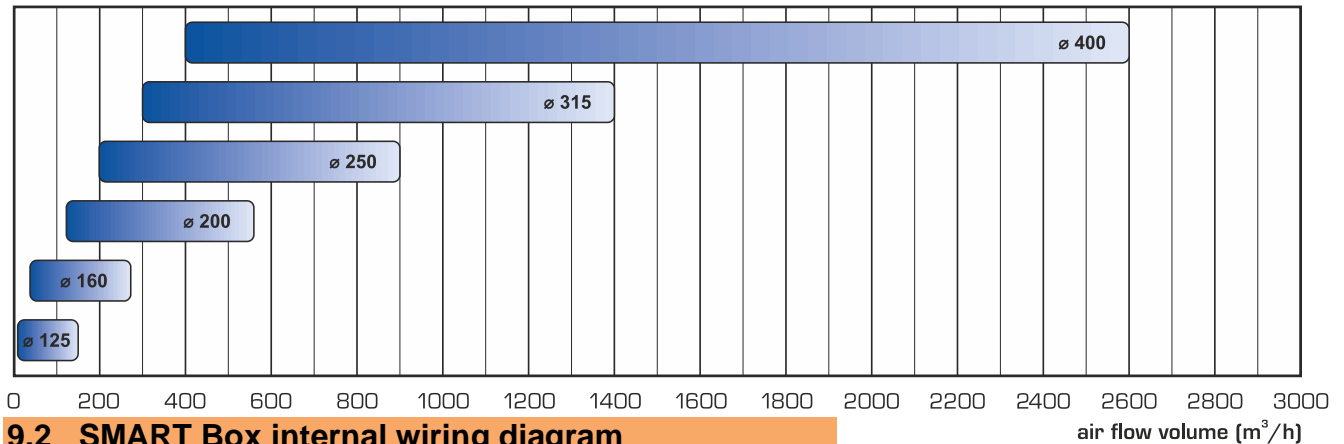

9.2 SMART Box internal wiring diagram

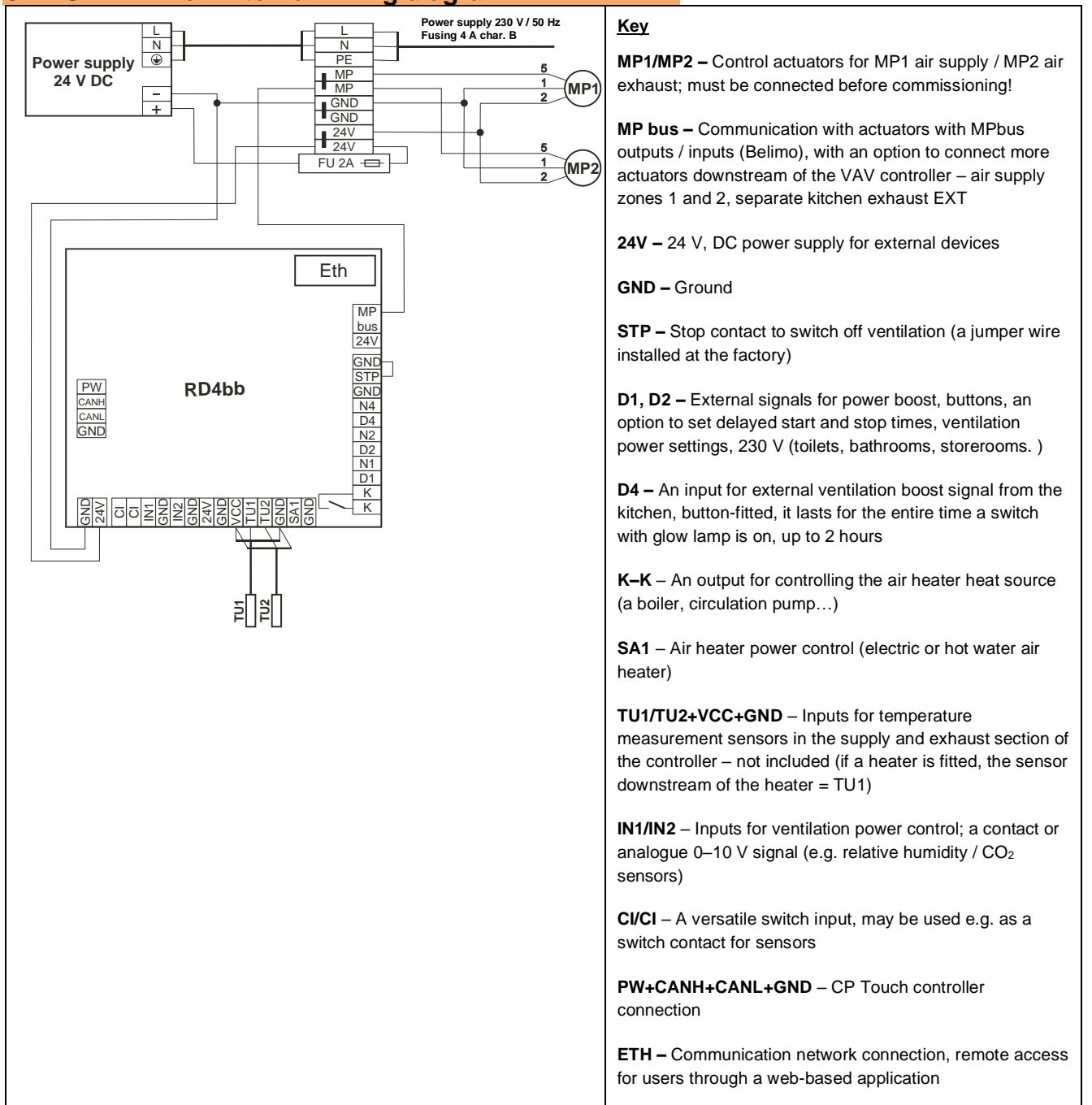

9.3 System connection schematic – Communication network topology

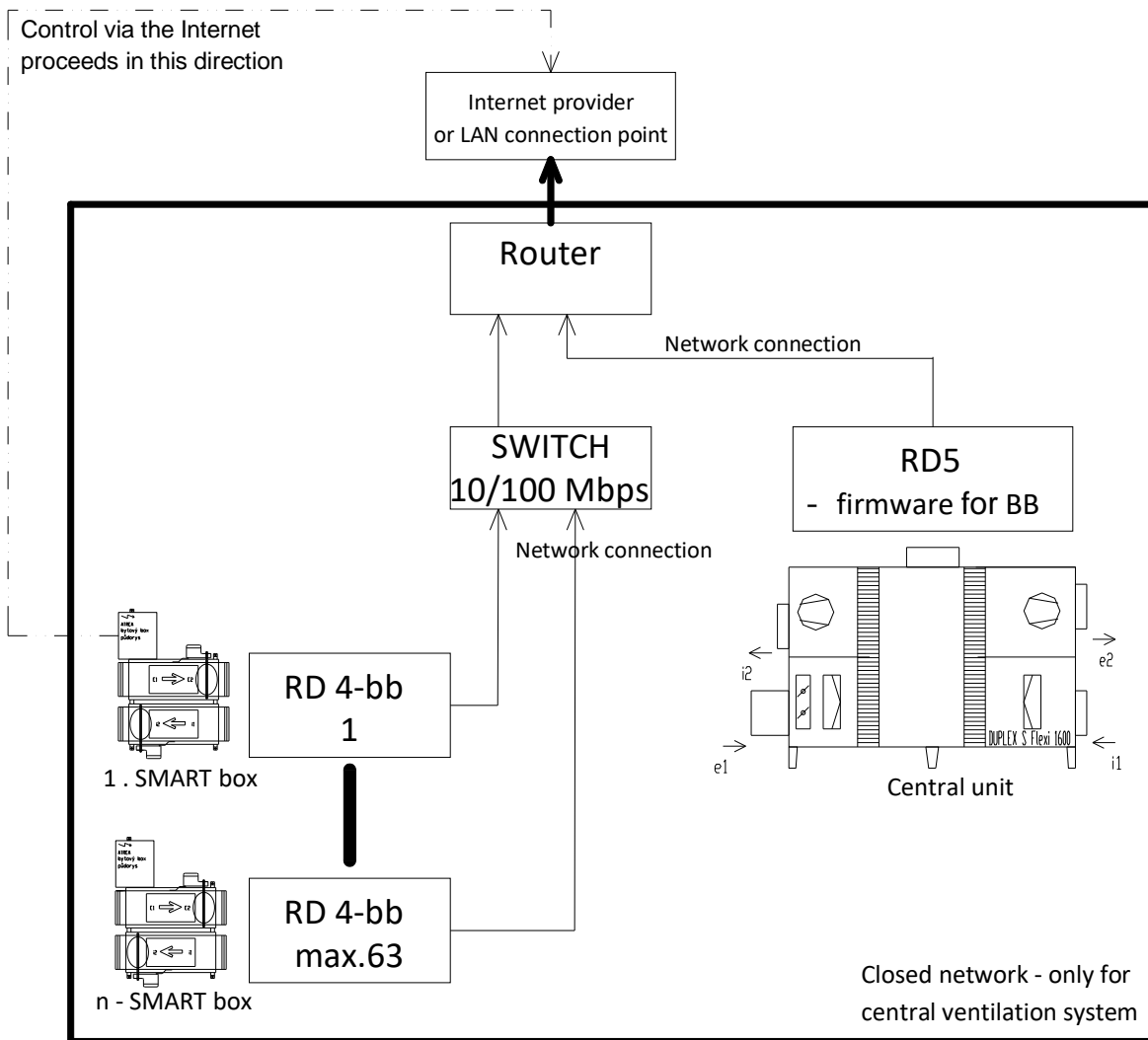

9.4 Reference diagram of SMART Box connections to other features

terminals controls	cable	use of	check
--------------------	-------	--------	-------

Power supply

	CYKY 3Jx1,5	SMART box RD5 230V/4A fusing 4A char. B		<input type="checkbox"/>
--	-------------	---	--	--------------------------

Control and communication

	SYKFY 2x2x0,5		CP Touch controller parallel connection of multiple controllers - see user instructions maximum length of flat cable - 50 m	<input type="checkbox"/>
	SYKFY 5x2x0,5		CP 10 RT controller (fan power and air temperature control) - maximum length of flat cable - 25 m	<input type="checkbox"/>
	CYKY 20x1,5 CYKY 20x1,5 CYKY 20x1,5		Lighting, Pressbutton (Toilet, Bathroom) Lighting, Pressbutton (Toilet, Bathroom) A switch External inputs (for signals 230 V)	<input type="checkbox"/>
	SYKFY 2x2x0,5		Emergency STOP contact	<input type="checkbox"/>
	CYKY 30x1,5		Zone ventilation damper servo drive - zone No.1 Supply voltage 24V, max. 2W (BELIMO LM24A-MP) (not part of delivery)	<input type="checkbox"/>
	CYKY 30x1,5		Zone ventilation damper servo drive - zone No.2 Supply voltage 24V, max. 2W (BELIMO LM24A-MP) (not part of delivery)	<input type="checkbox"/>
	CYKY 30x1,5		Servo drive kitchen extraction damper Control voltage 24V, max. 2W (BELIMO LM24A-MP)	<input type="checkbox"/>

External sensors

	SYKFY 2x2x0,5		CO2 sensor ADS CO2-24 (Power supply 24V DC, max. 80 mA)	<input type="checkbox"/>
	SYKFY 2x2x0,5		Electric heating coil EPO-PTC 160/0,4 Fusing 1x 10A (char.)	<input type="checkbox"/>
	SYKFY 2x2x0,5		Supply air (SUP) temperature sensor ADS 120	<input type="checkbox"/>
	SYKFY 2x2x0,5		Sensor 0-10V (CO2, humidity, differential pressure etc.) or floating N.O. switch	<input type="checkbox"/>
	SYKFY 2x2x0,5		Sensor 0-10V (CO2, humidity, differential pressure etc.) or floating N.O. switch	<input type="checkbox"/>

The wiring diagram shows only terminals for connecting external conductors and devices.
 The terminals connected by the manufacturer are not shown.
 Do not run the low-current cables next to power cables ! (See applicable standards)



Call: 01494 525252

Visit: airflow.com



Airflow Developments Limited
Aidelje House, Lancaster Road,
Cressex Business Park,
High Wycombe, Buckinghamshire,
United Kingdom, HP12 3QP

E-mail: info@airflow.com
Telephone: +44 (0) 1494 525252
airflow.com

© Airflow Developments Limited, Airflow Developments Limited reserve the right, in the interests of continuous development, to alter specifications without prior notice. All orders are accepted subject to our conditions of sale which are available on request

80001133 Issue 1 01/22

